

TOMI

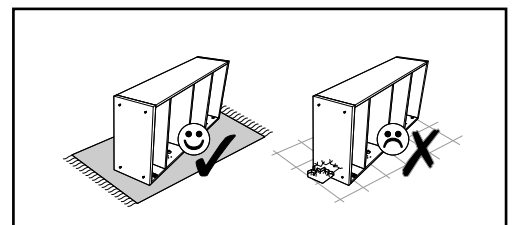

①	1797x550	1	1/5
②	1422x545	1	2/5
③	1797x550	1	1/5
④	1000x570	1	3/5
⑤	545x497	1	4/5
⑥	545x445	3	4/5
⑦	960x545	1	3/5
⑧	960x550	1	3/5
⑨	994x60	1	5/5
⑩	994x60	1	5/5
⑪	1366x496	1	2/5
⑫	1366x496	1	2/5
⑬	994x300	1	5/5
⑭	450x220	1	5/5
⑮	432x206	1	5/5
⑯	450x220	1	5/5
⑰	898x220	1	5/5
⑱	912x446	1	1/5
⑲	1453x520	1	1/5
⑳	1453x468	1	1/5
㉑	960x292	1	5/5

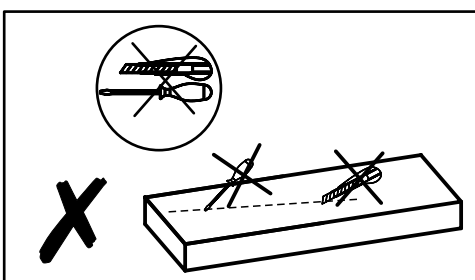
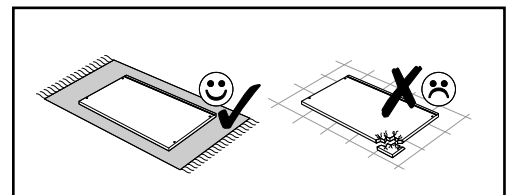
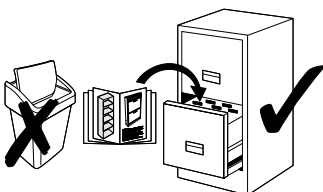
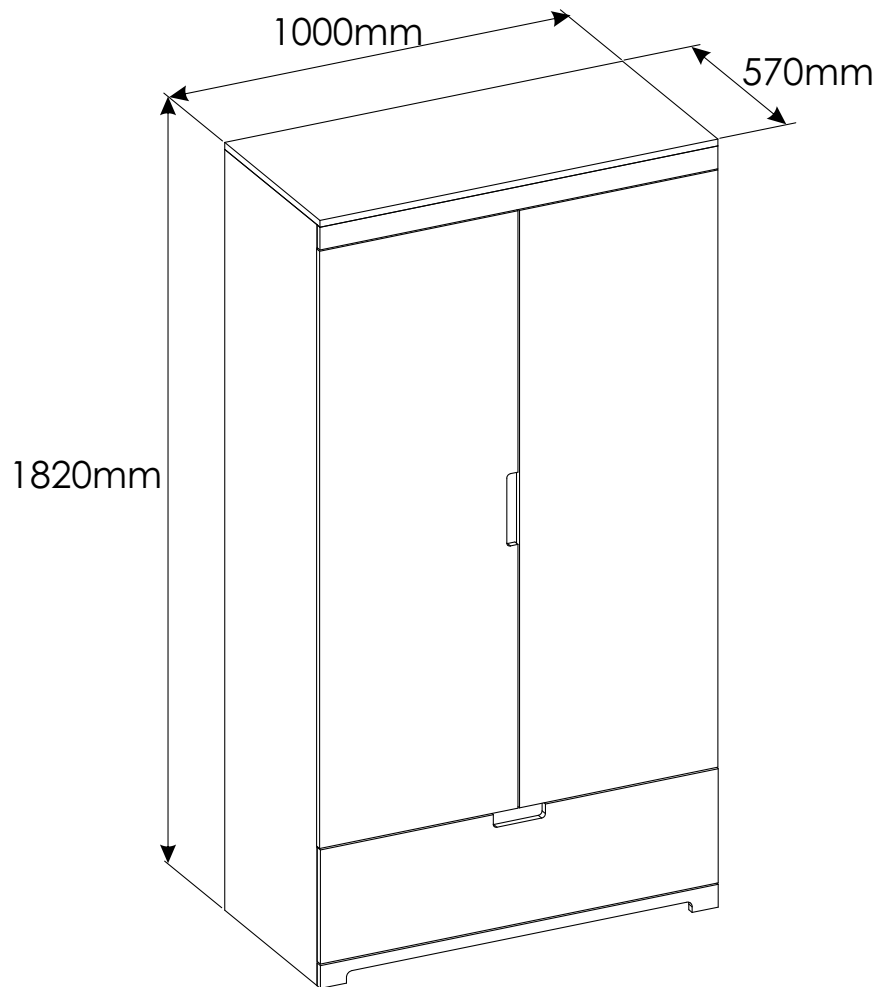
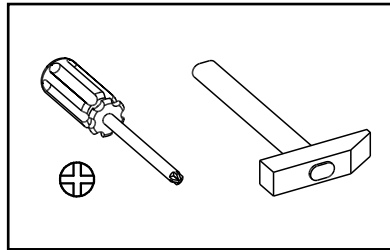
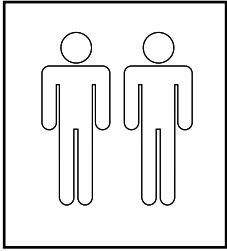
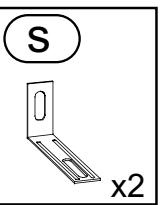
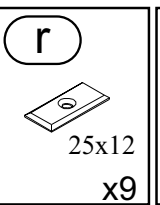
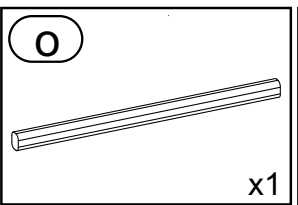
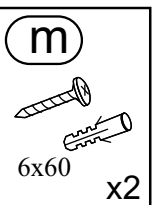
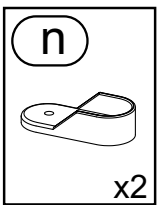
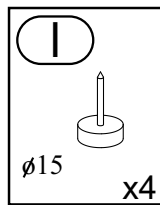
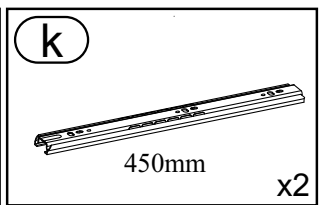
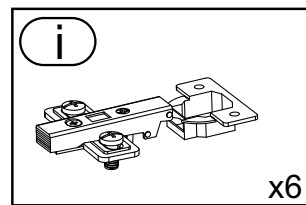
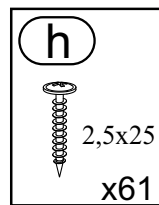
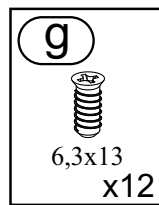
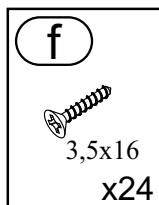
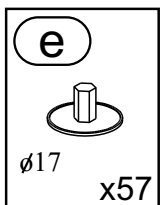
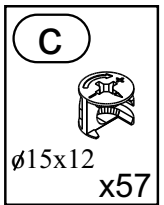
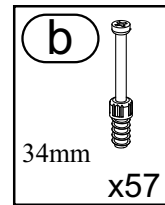
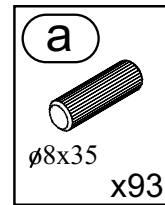
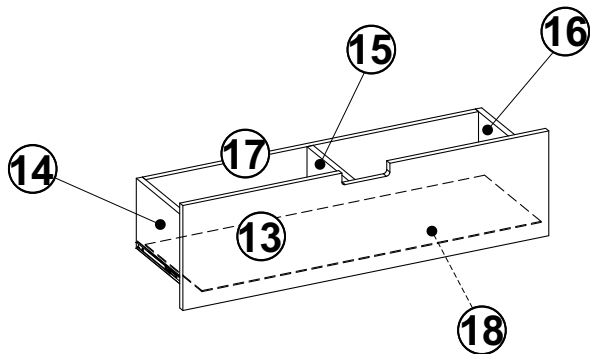
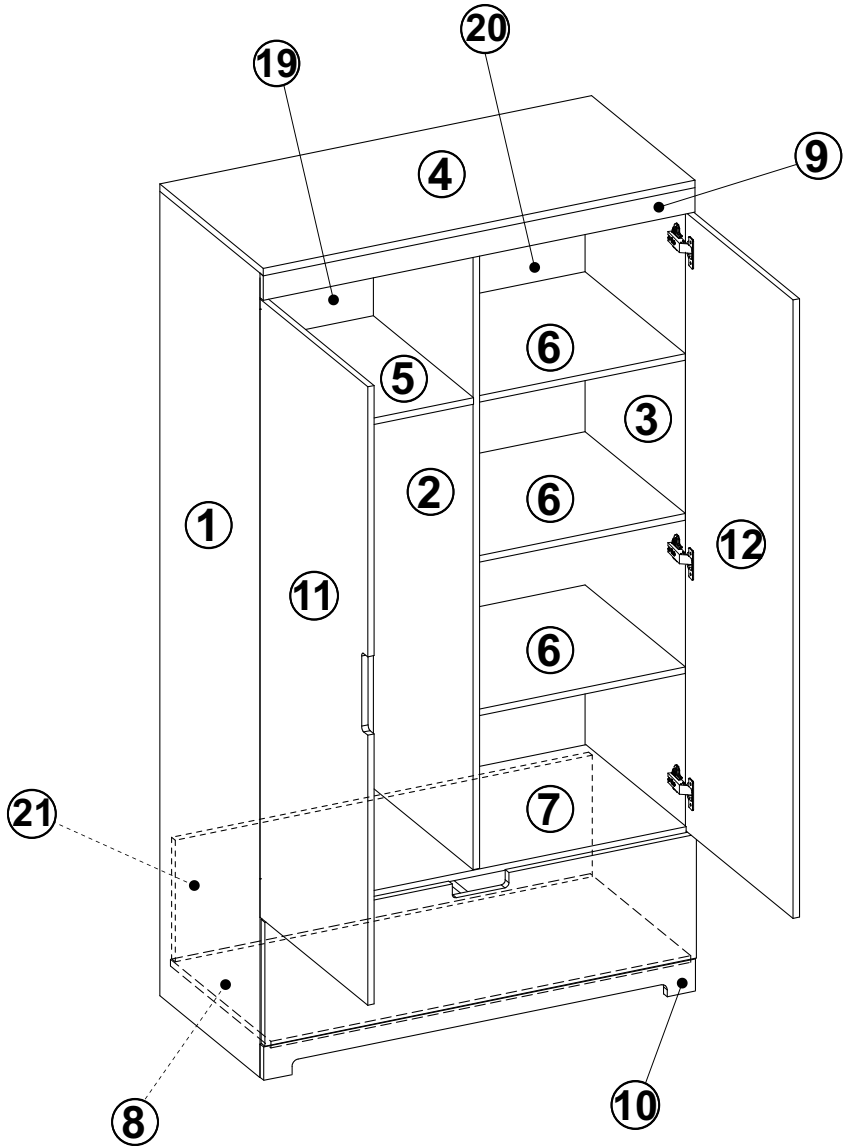

1

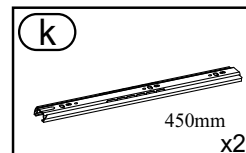
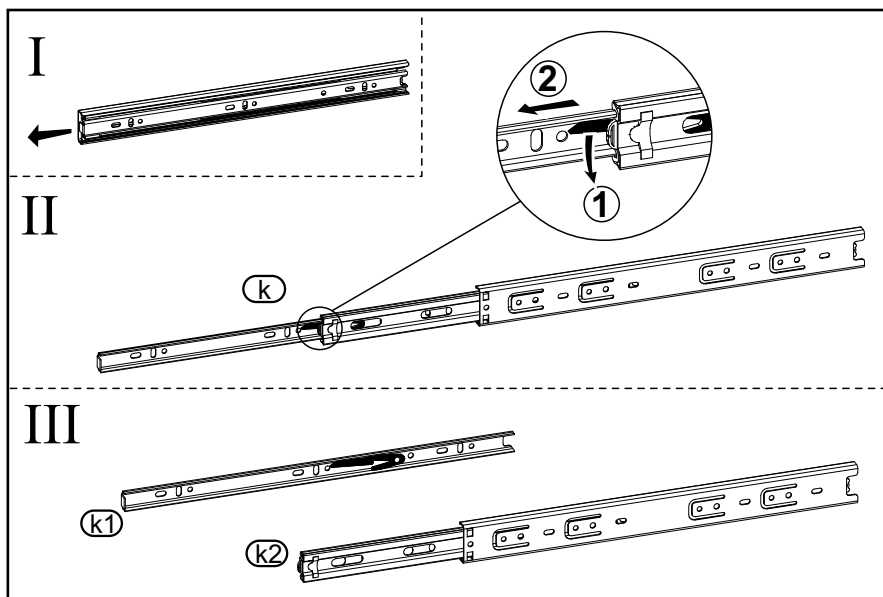

2

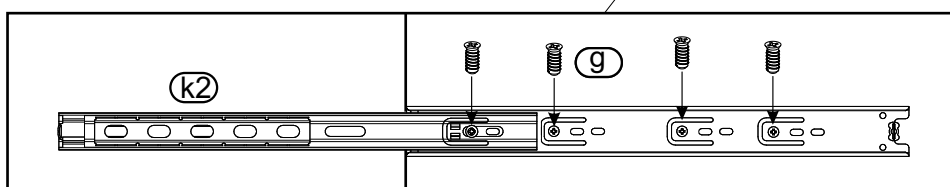
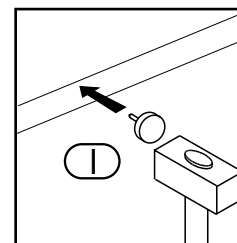
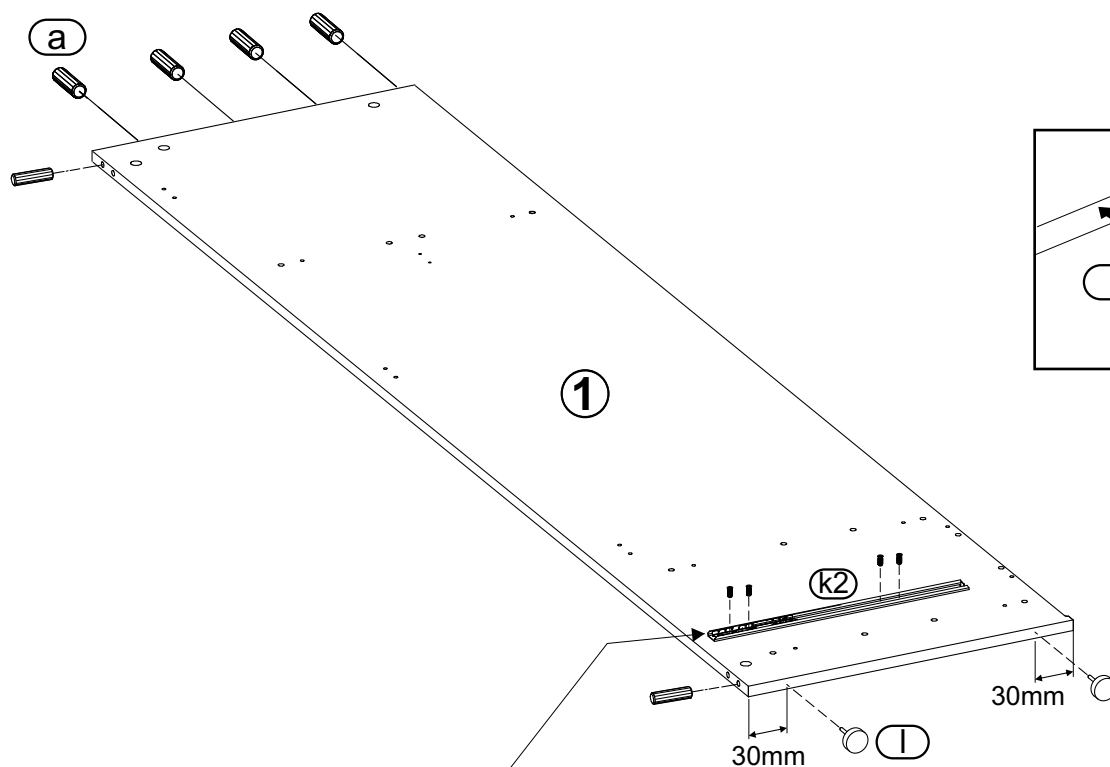
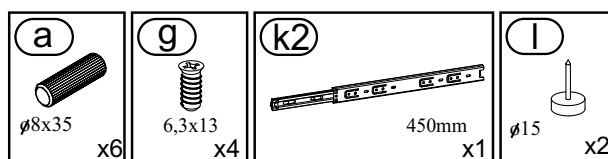
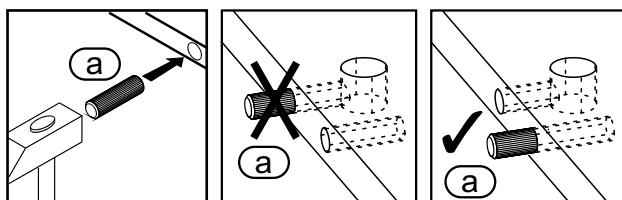

3

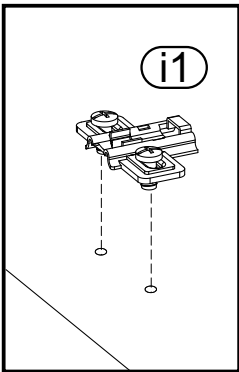
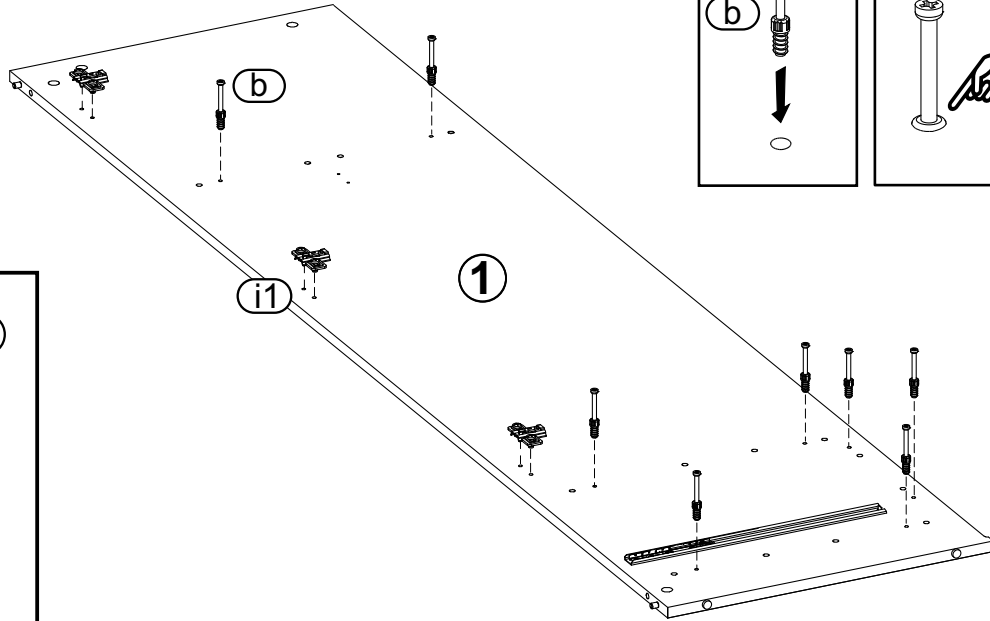
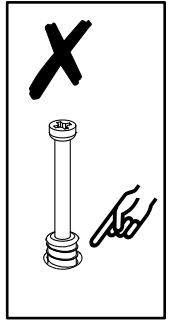
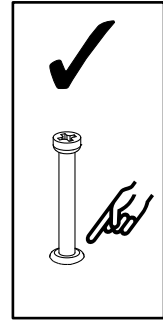
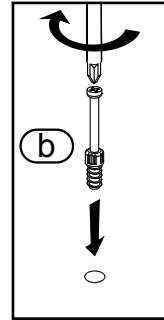
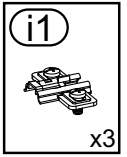
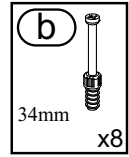
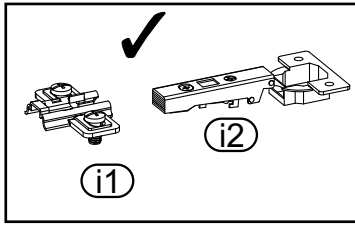
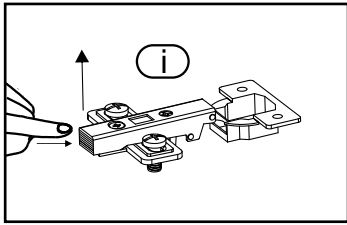

4

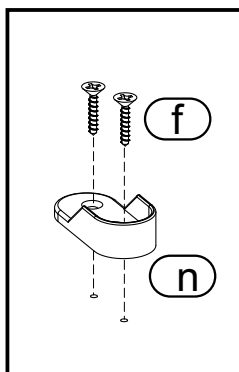
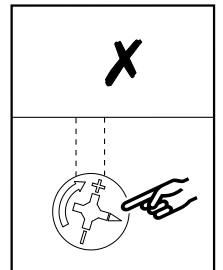
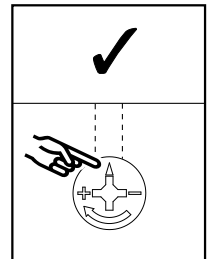
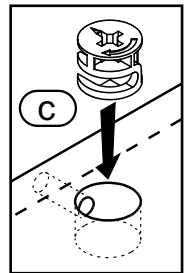
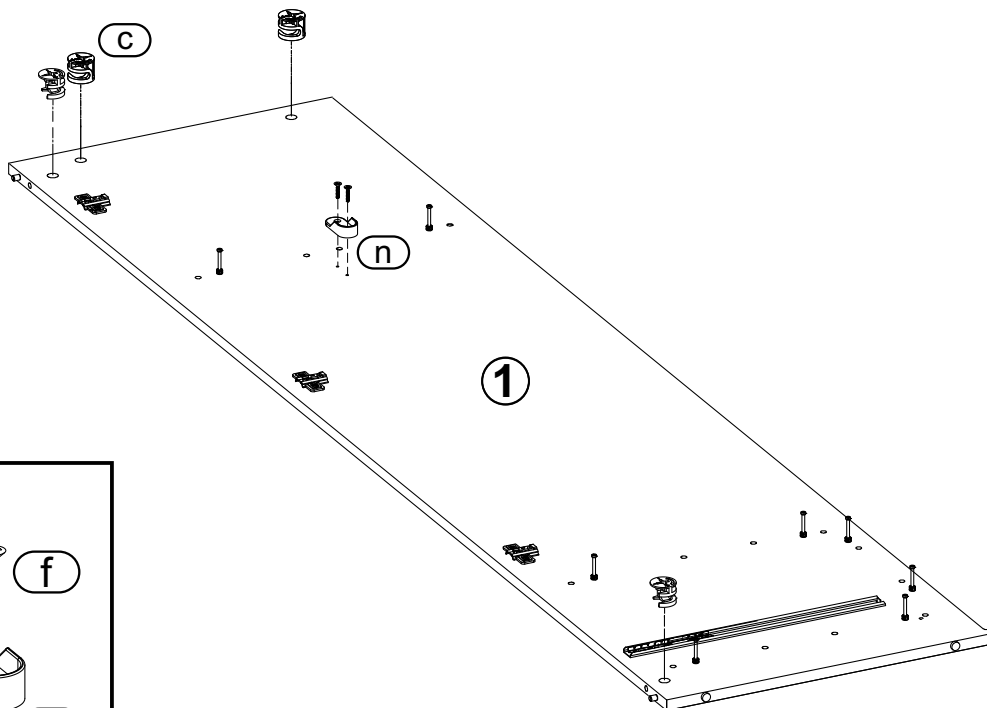
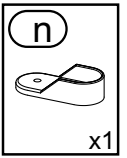
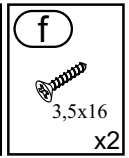
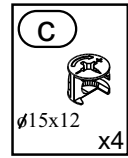

5

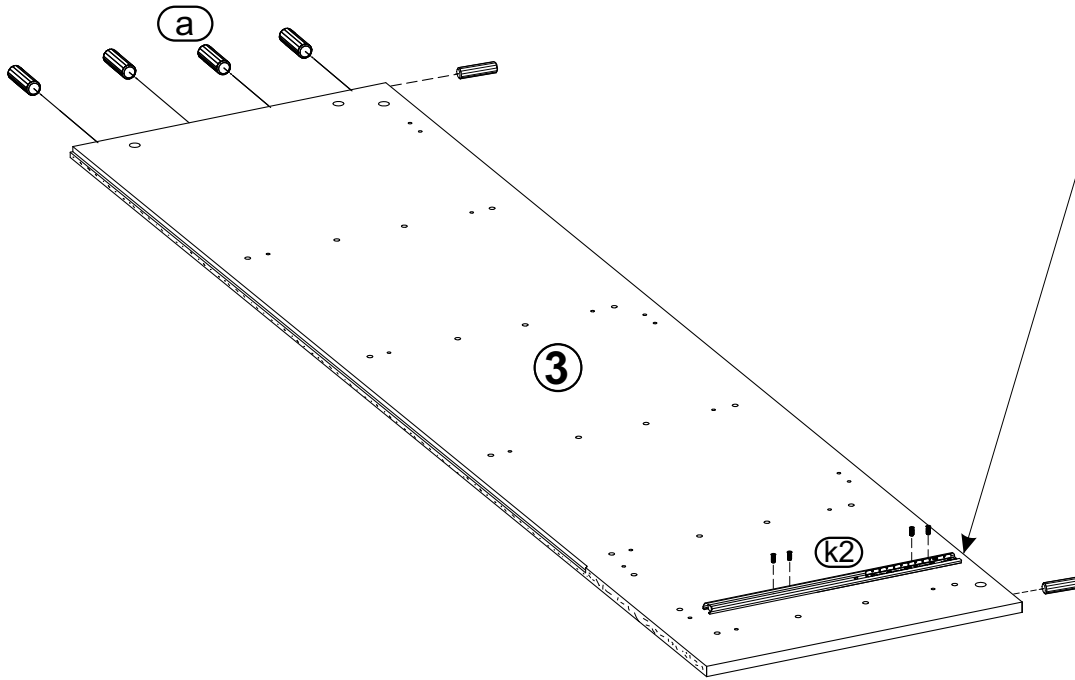
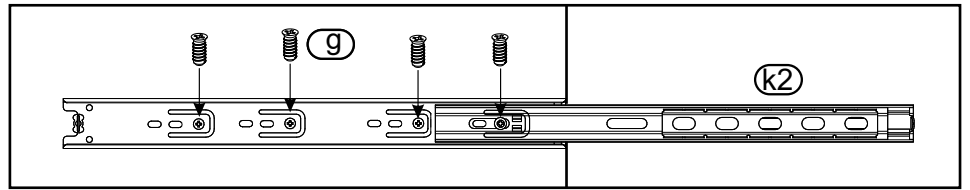
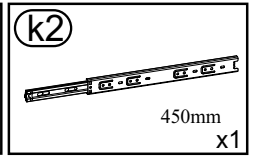
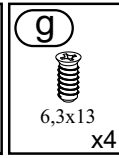
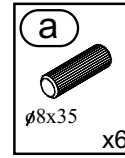
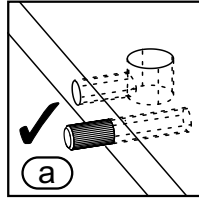
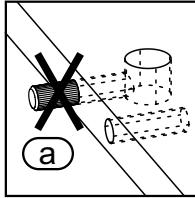
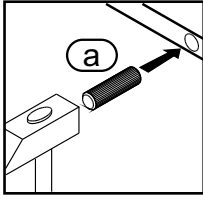

6

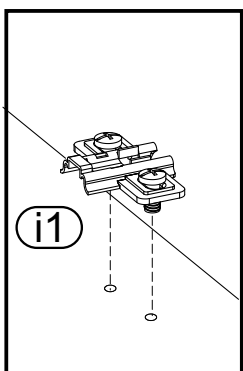
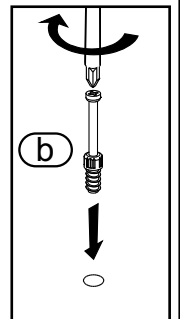
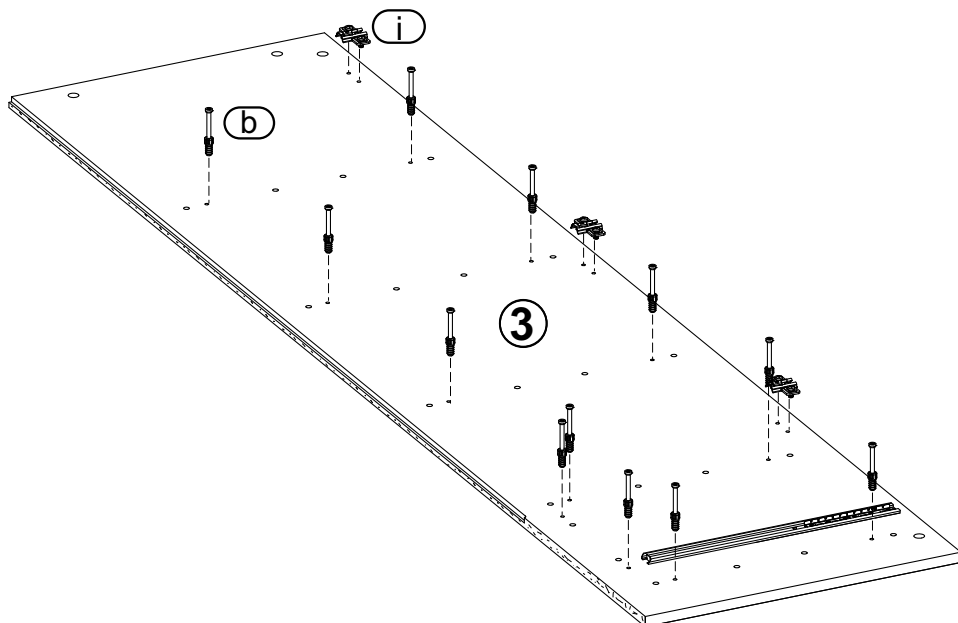
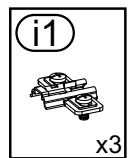
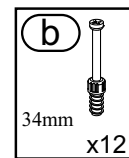
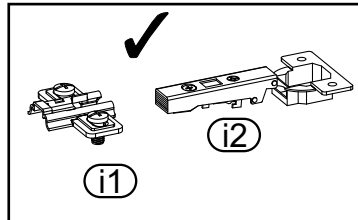
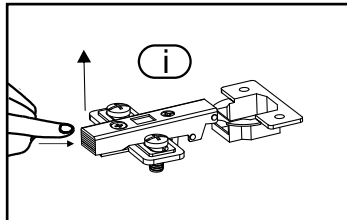

7

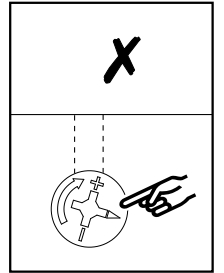
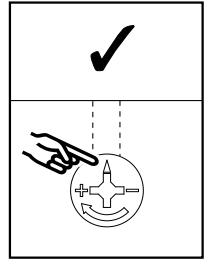
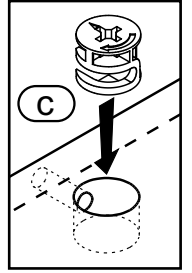
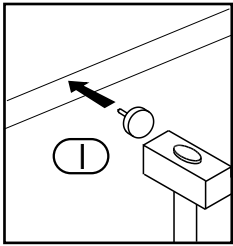
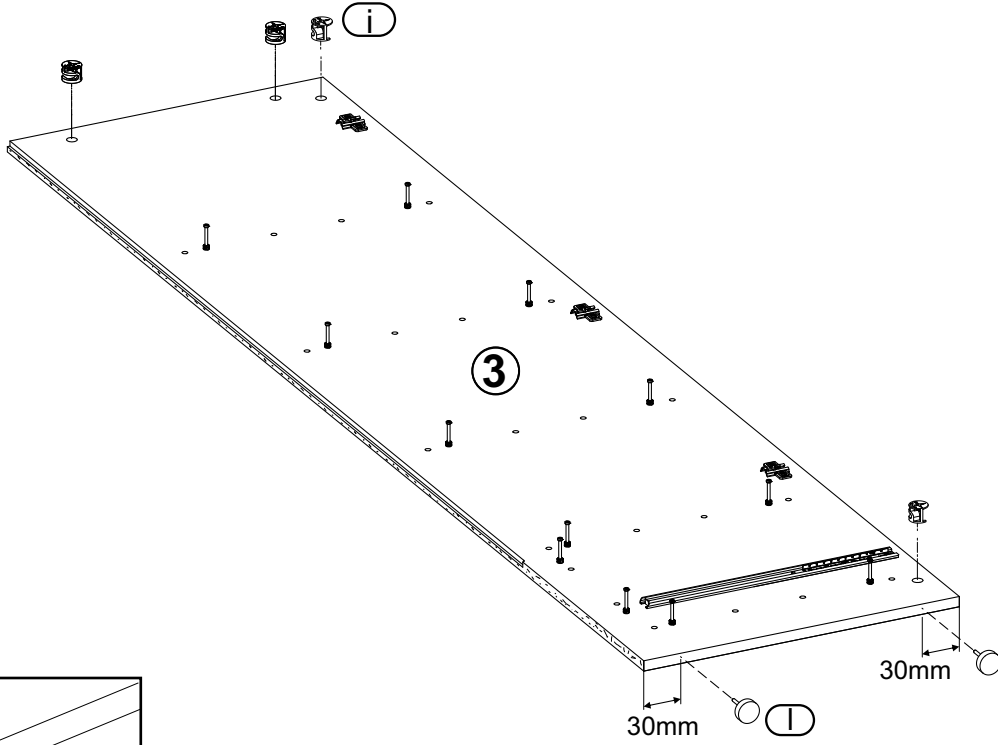
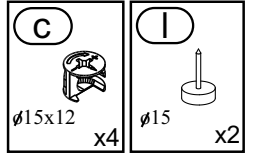

8

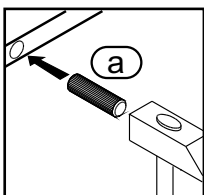
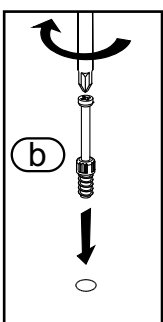
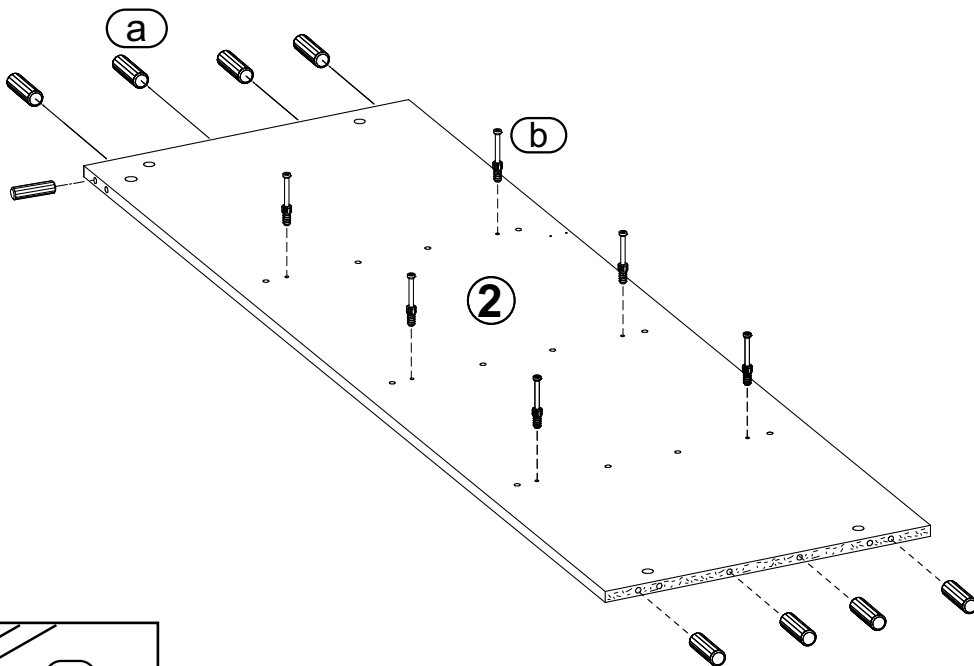
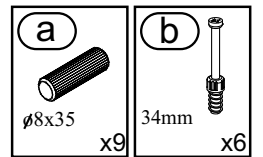

9

- b** 34mm x10
- g** 6,3x13 x4
- s** x2

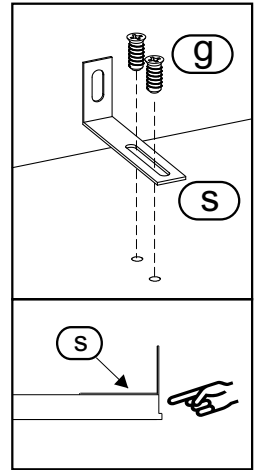
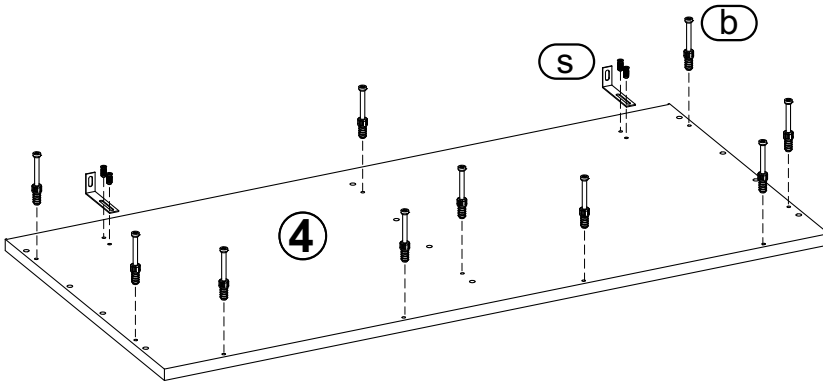

10

- a** $\phi 8 \times 35$ x8
- b** 34mm x3
- c** $\phi 15 \times 12$ x9

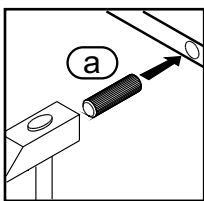
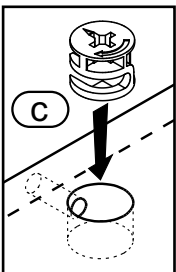
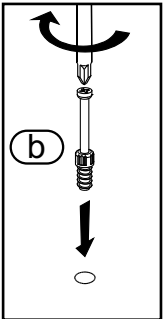
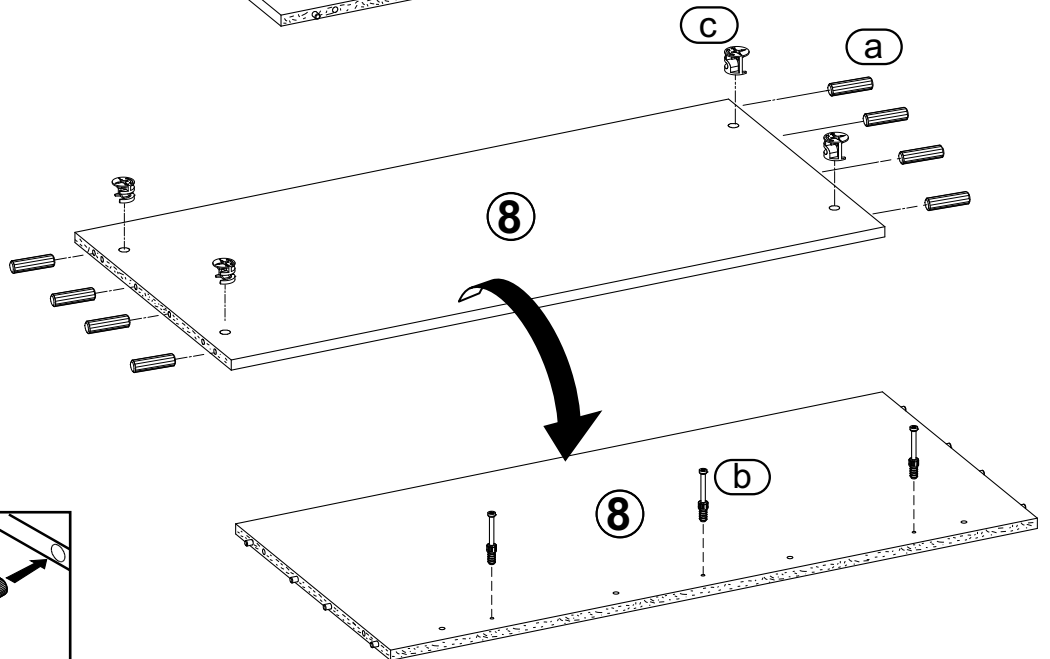
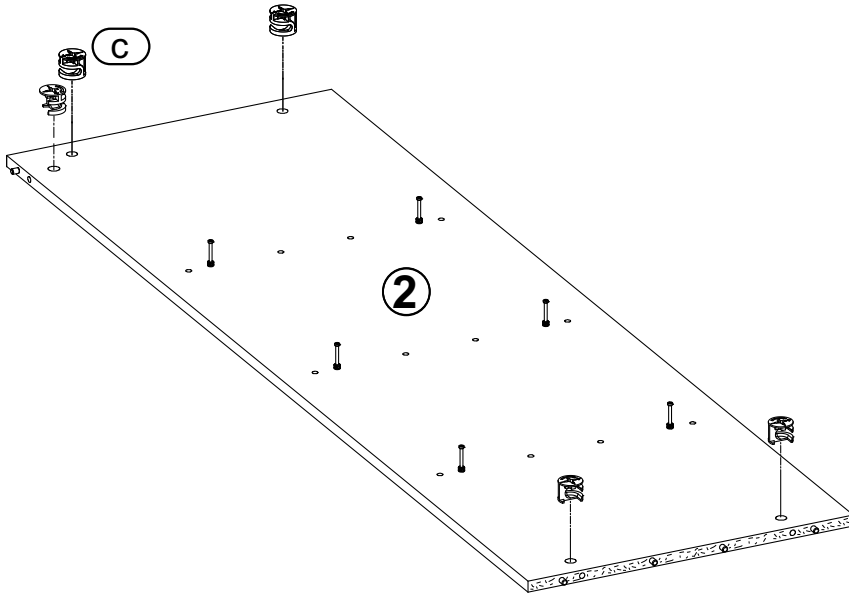

11

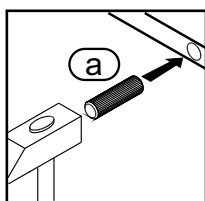
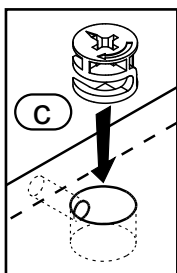
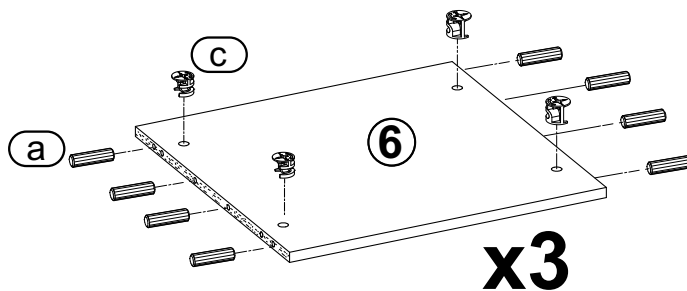
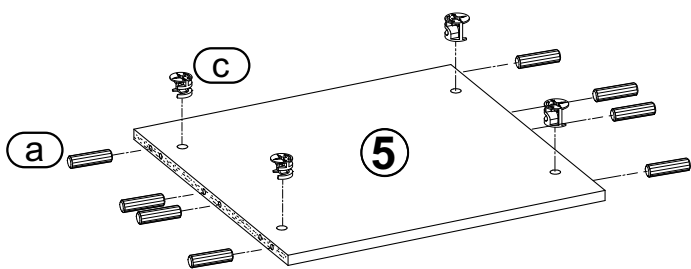
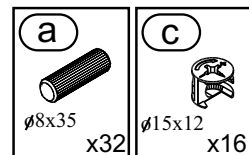

12

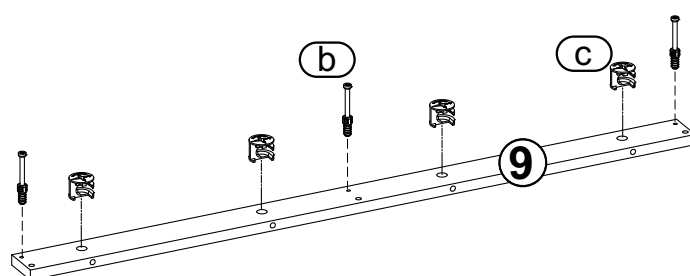
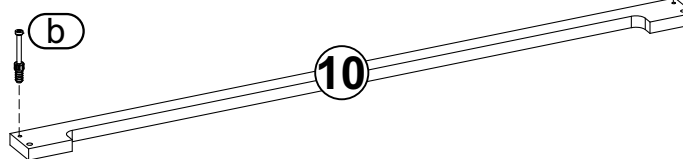
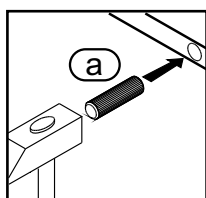
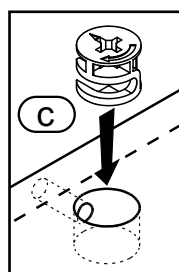
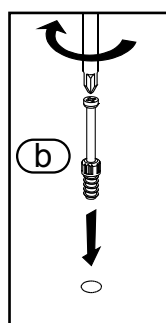
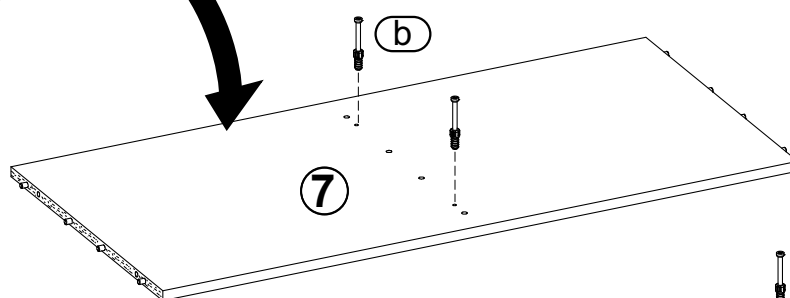
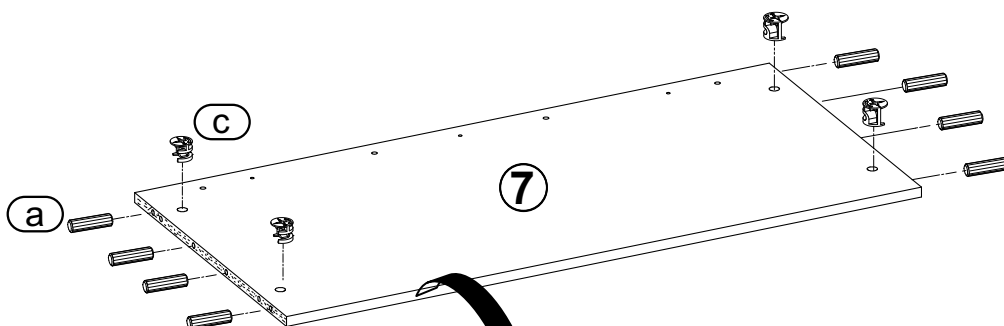
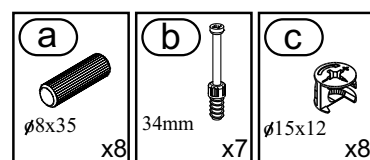

13

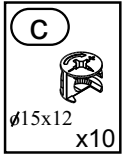
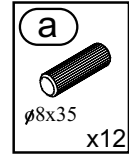
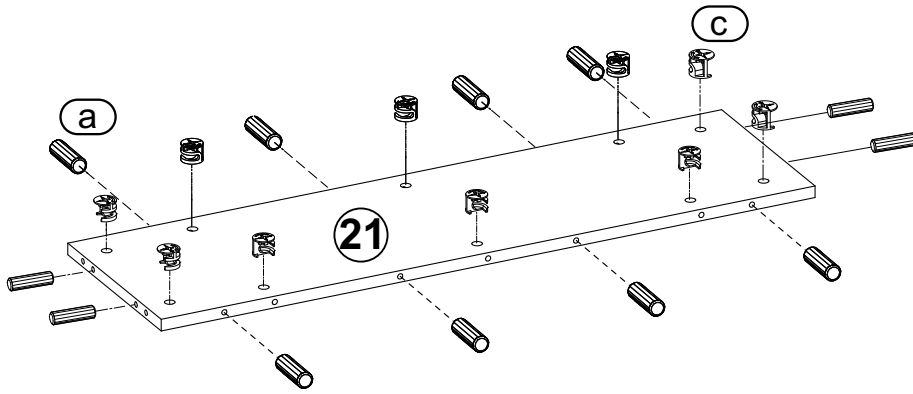

14

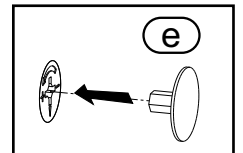
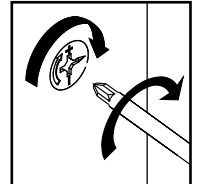
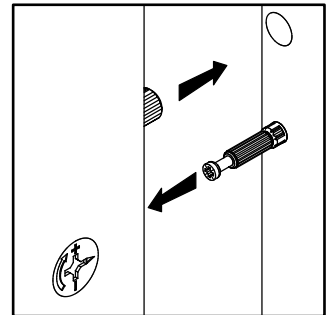
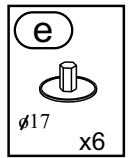
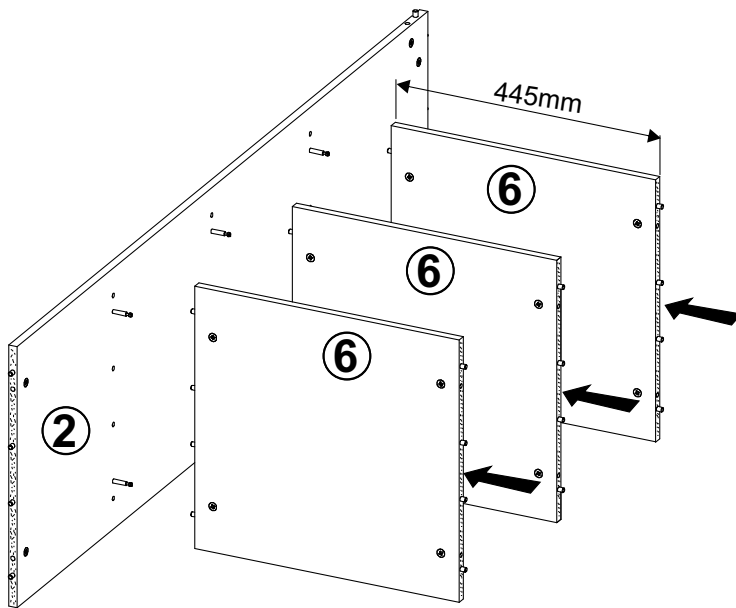

15

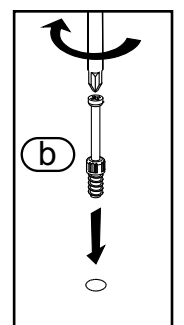
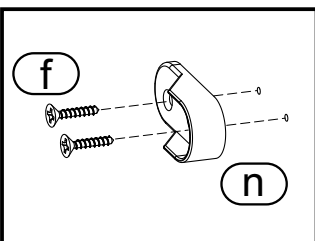
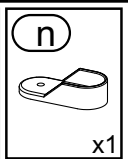
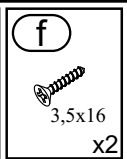
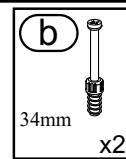
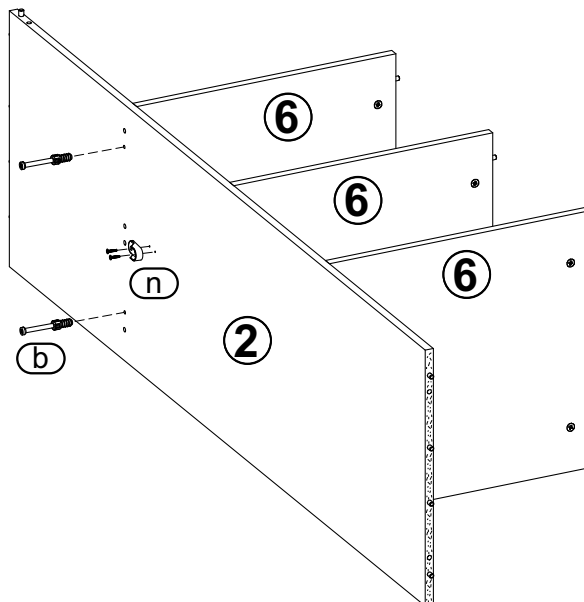

16

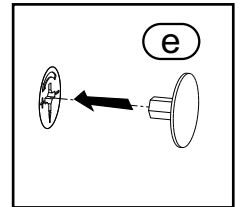
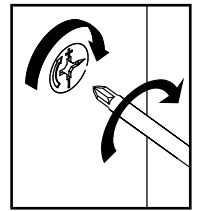
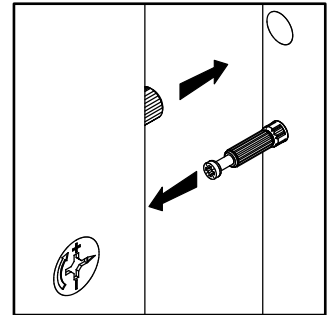
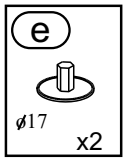
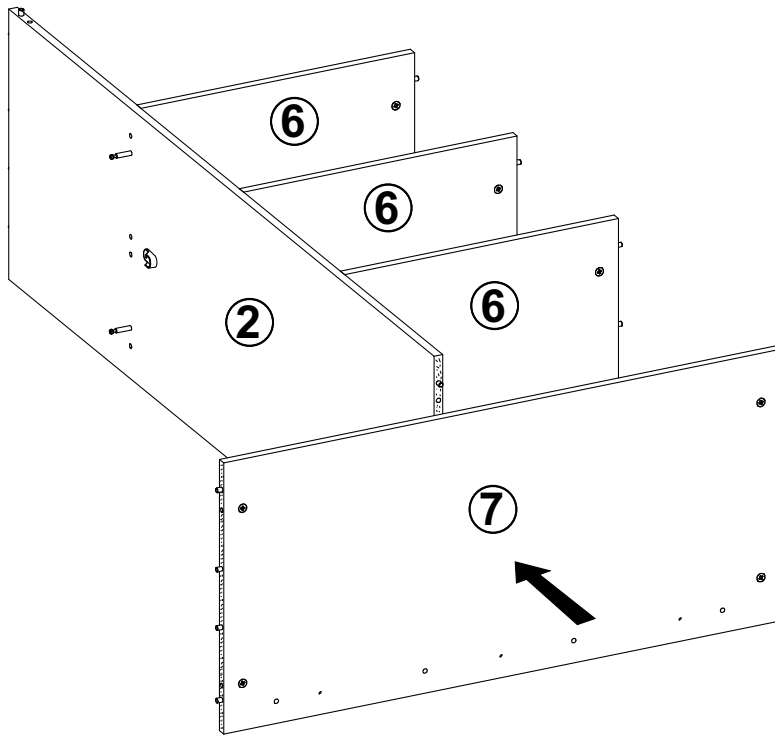

17

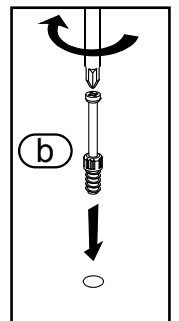
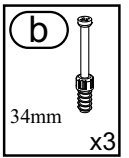
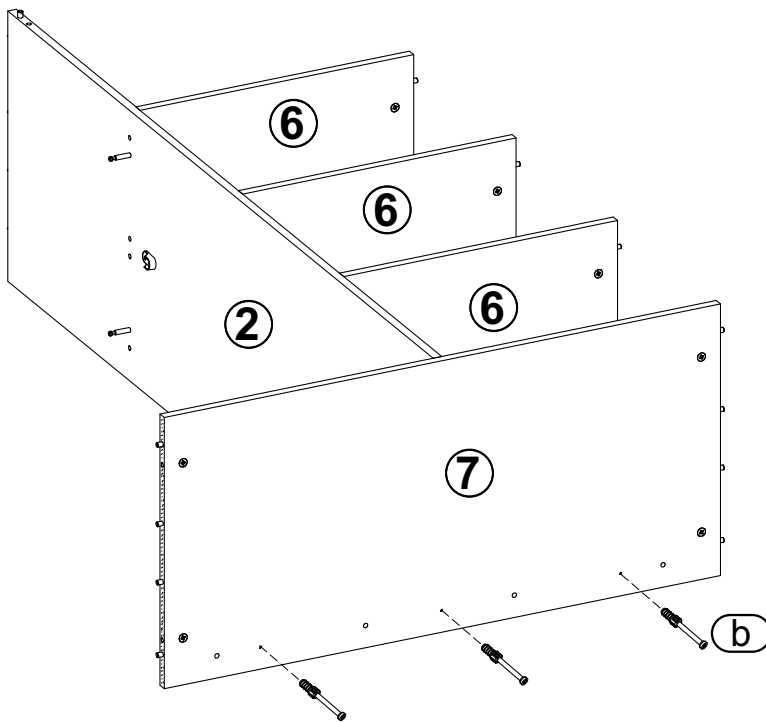

18

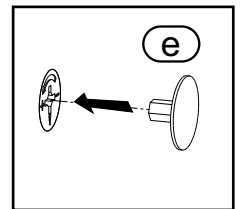
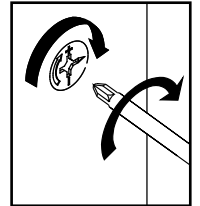
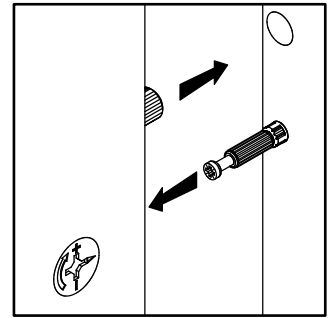
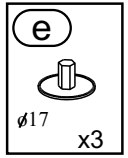
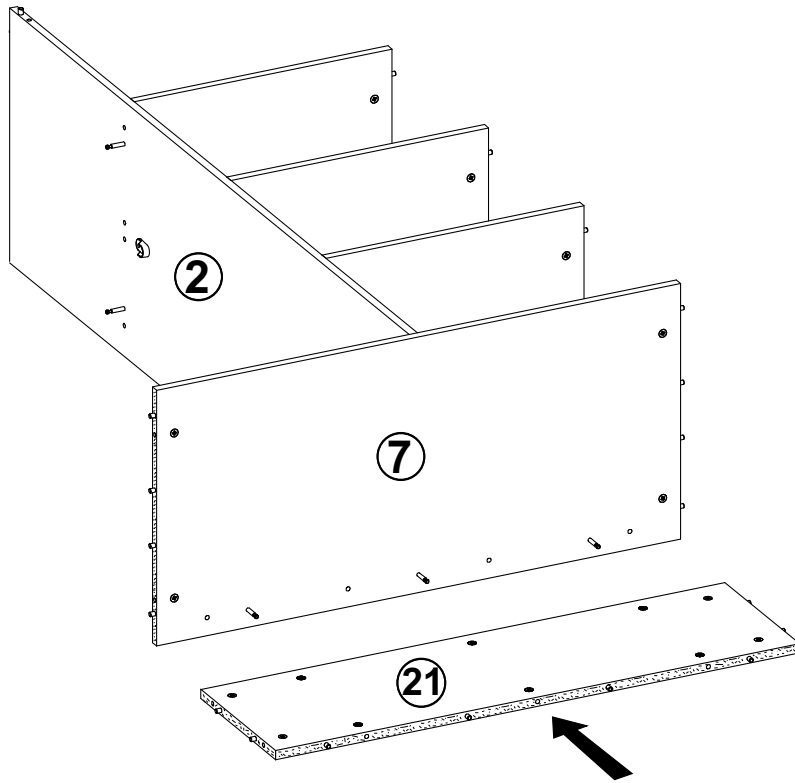

19

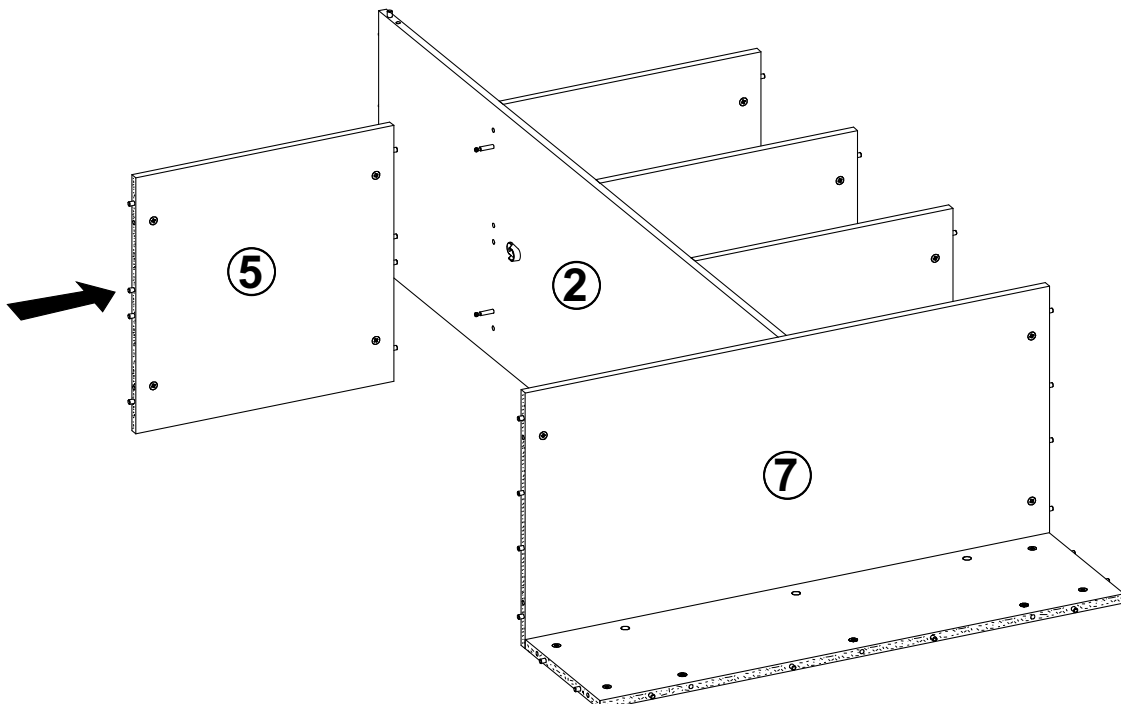
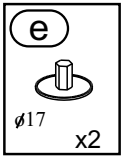
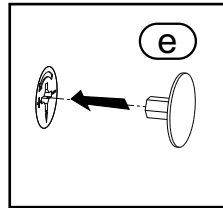
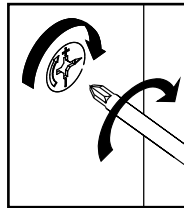
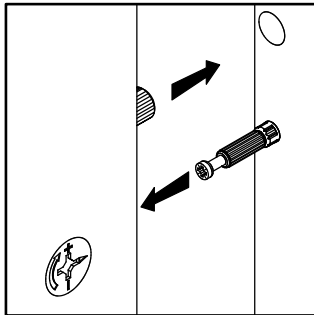

20

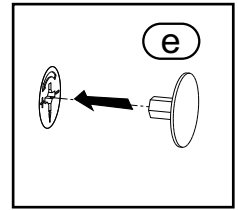
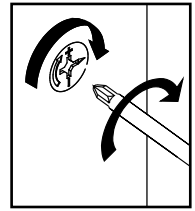
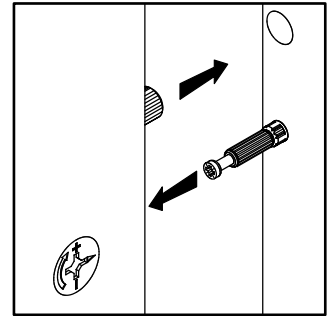
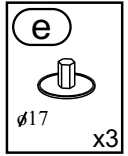
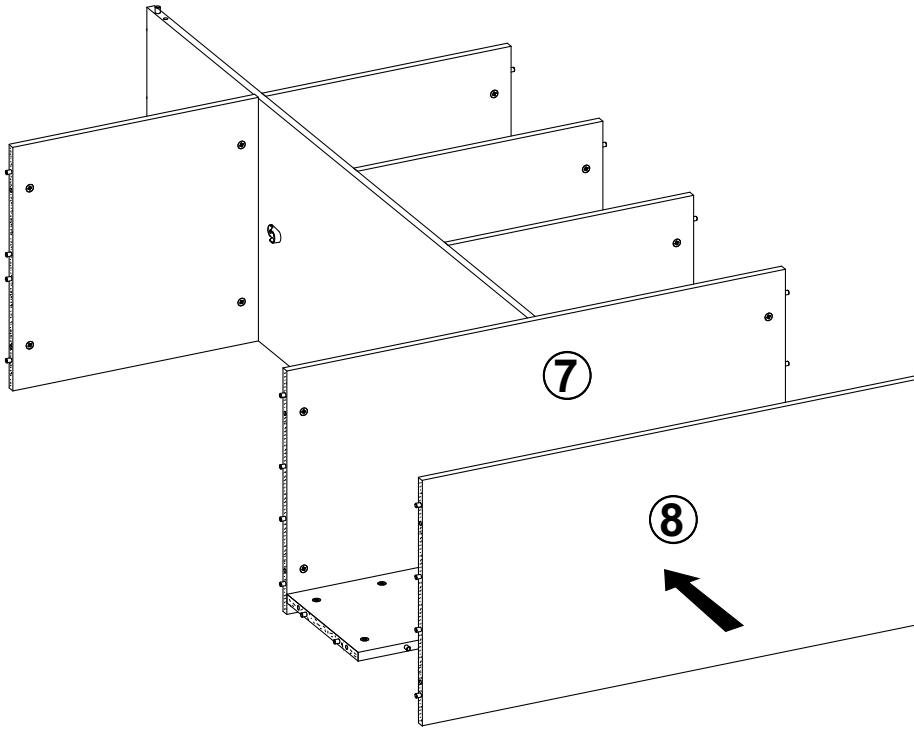

21

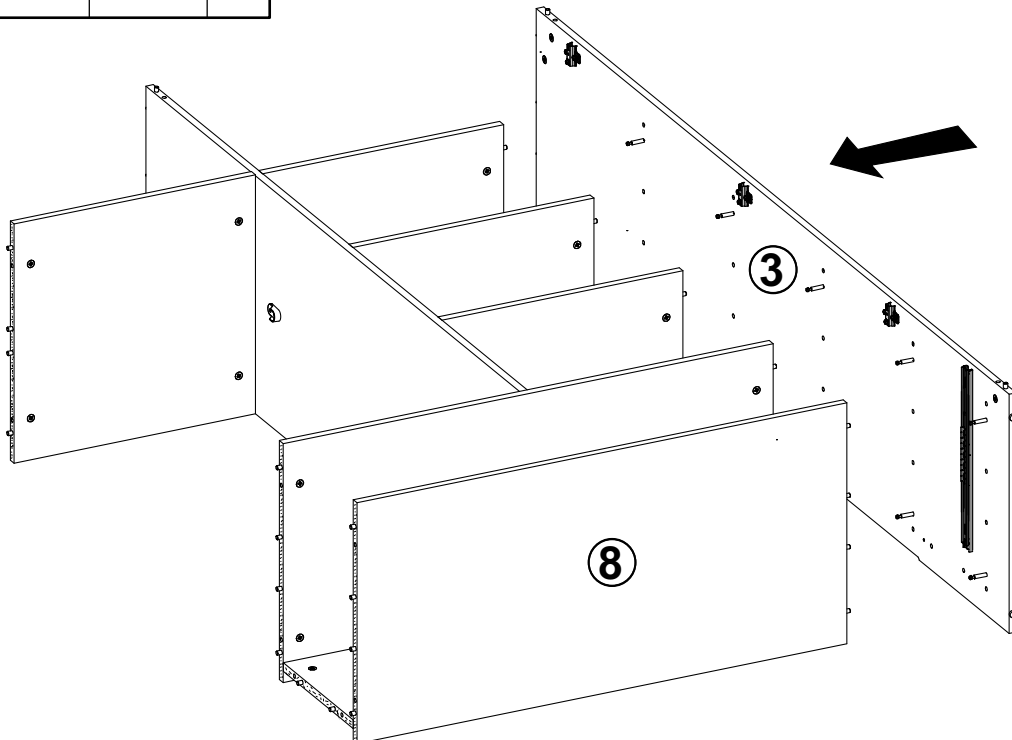
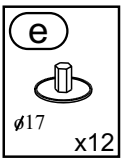
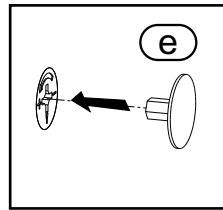
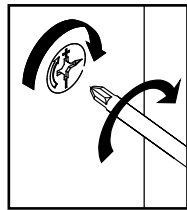
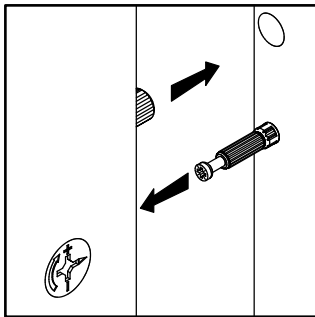

22

e
ø17
x8

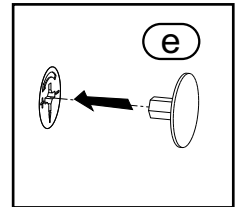
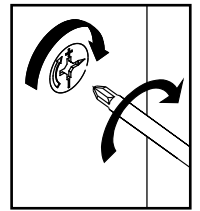
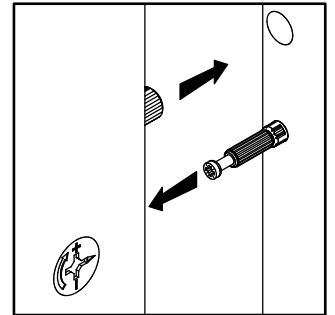
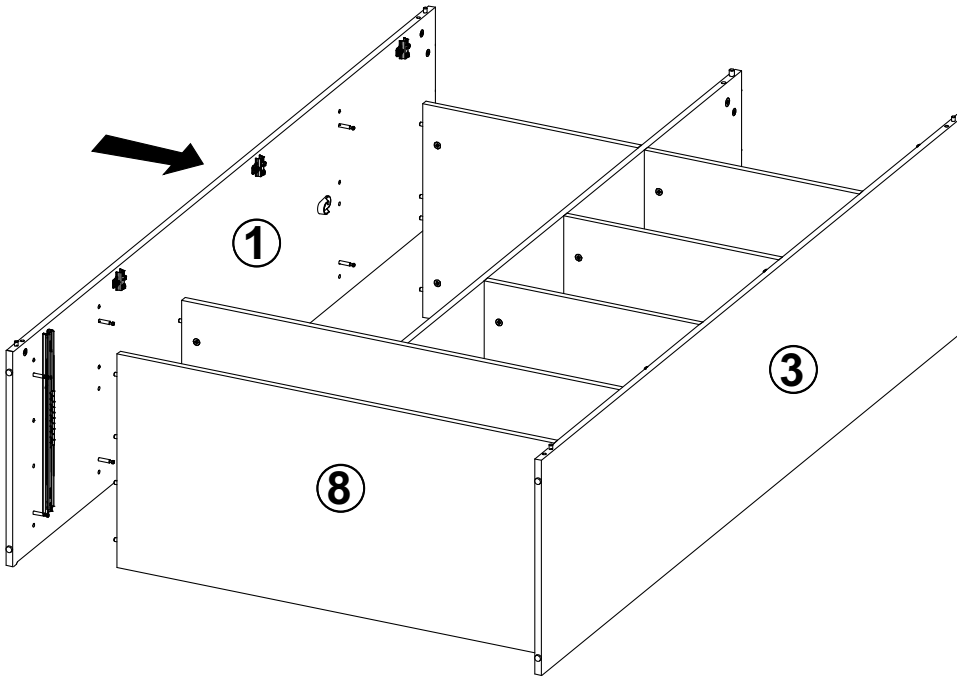

23

e
ø17
x5

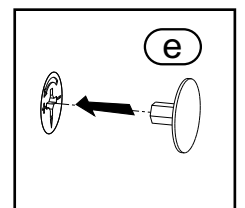
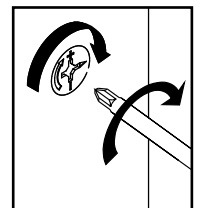
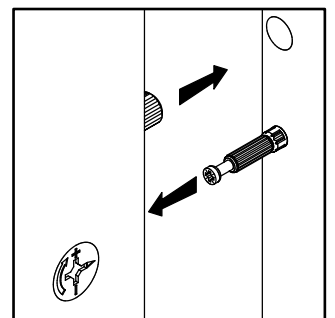
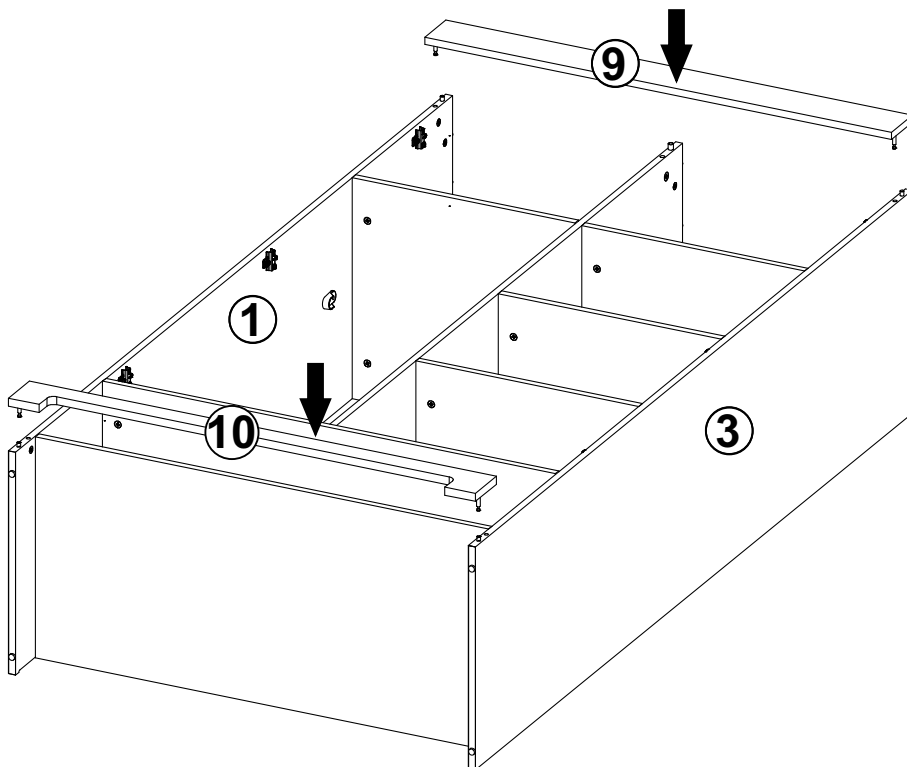

24

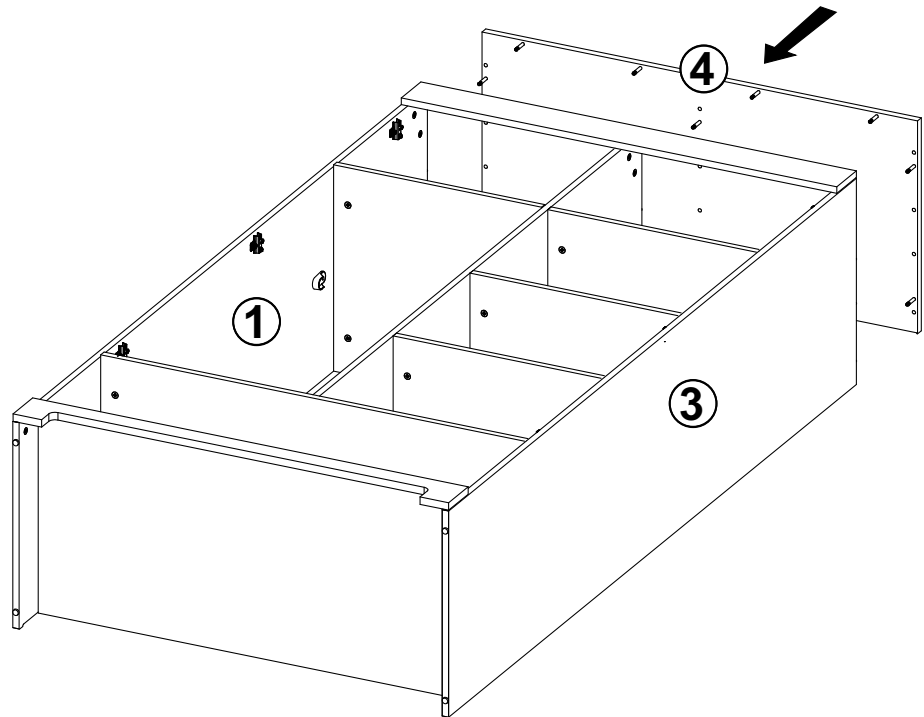
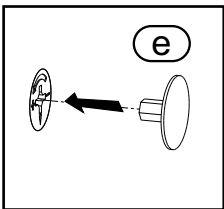
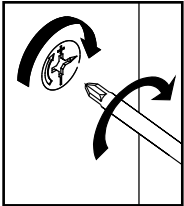
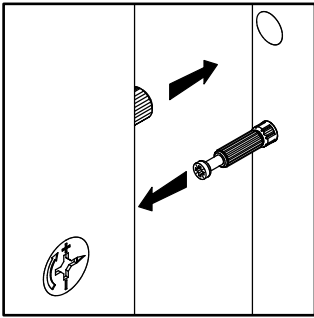
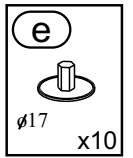

25

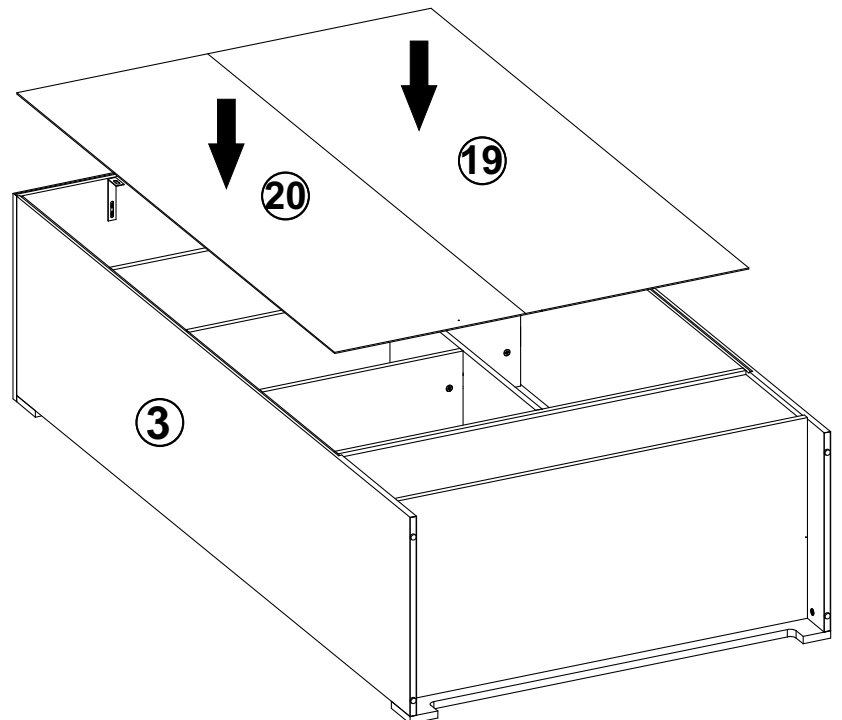
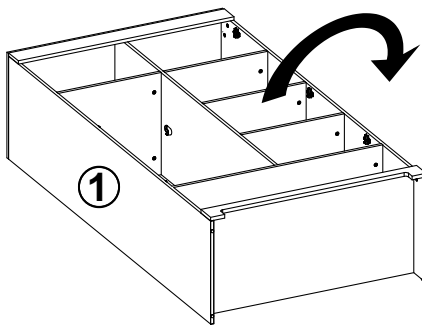
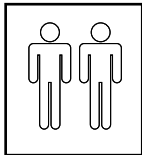

26

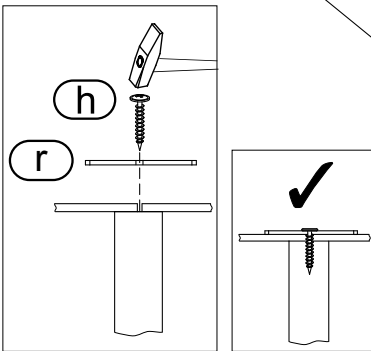
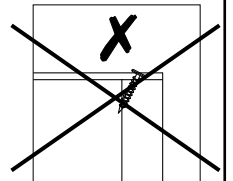
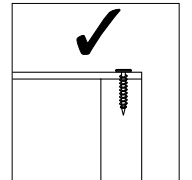
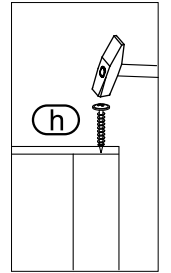
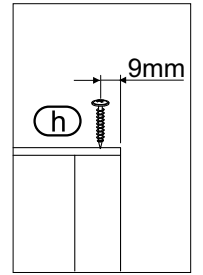
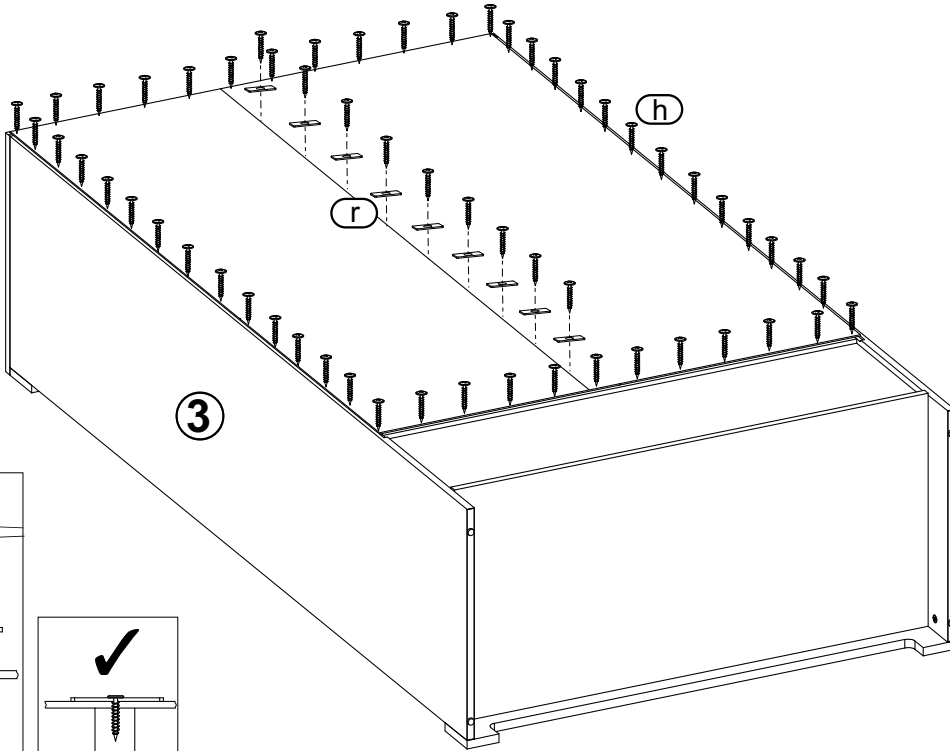
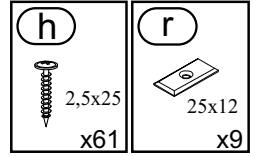
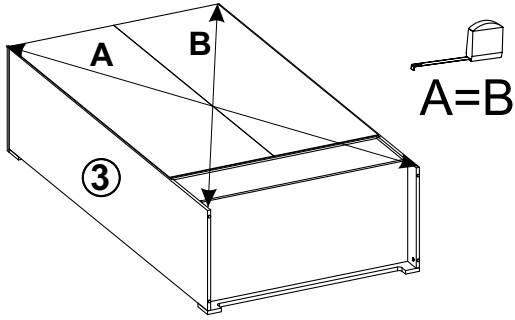

27

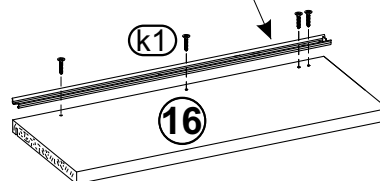
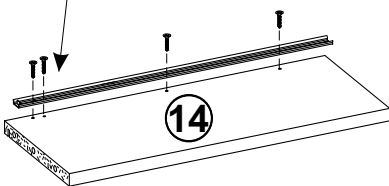
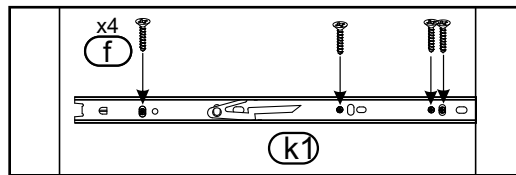
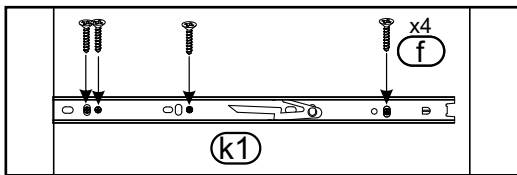
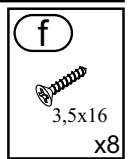
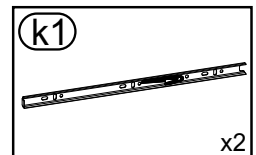

28

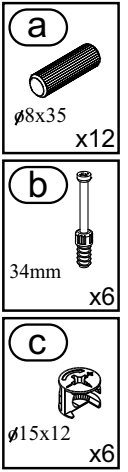
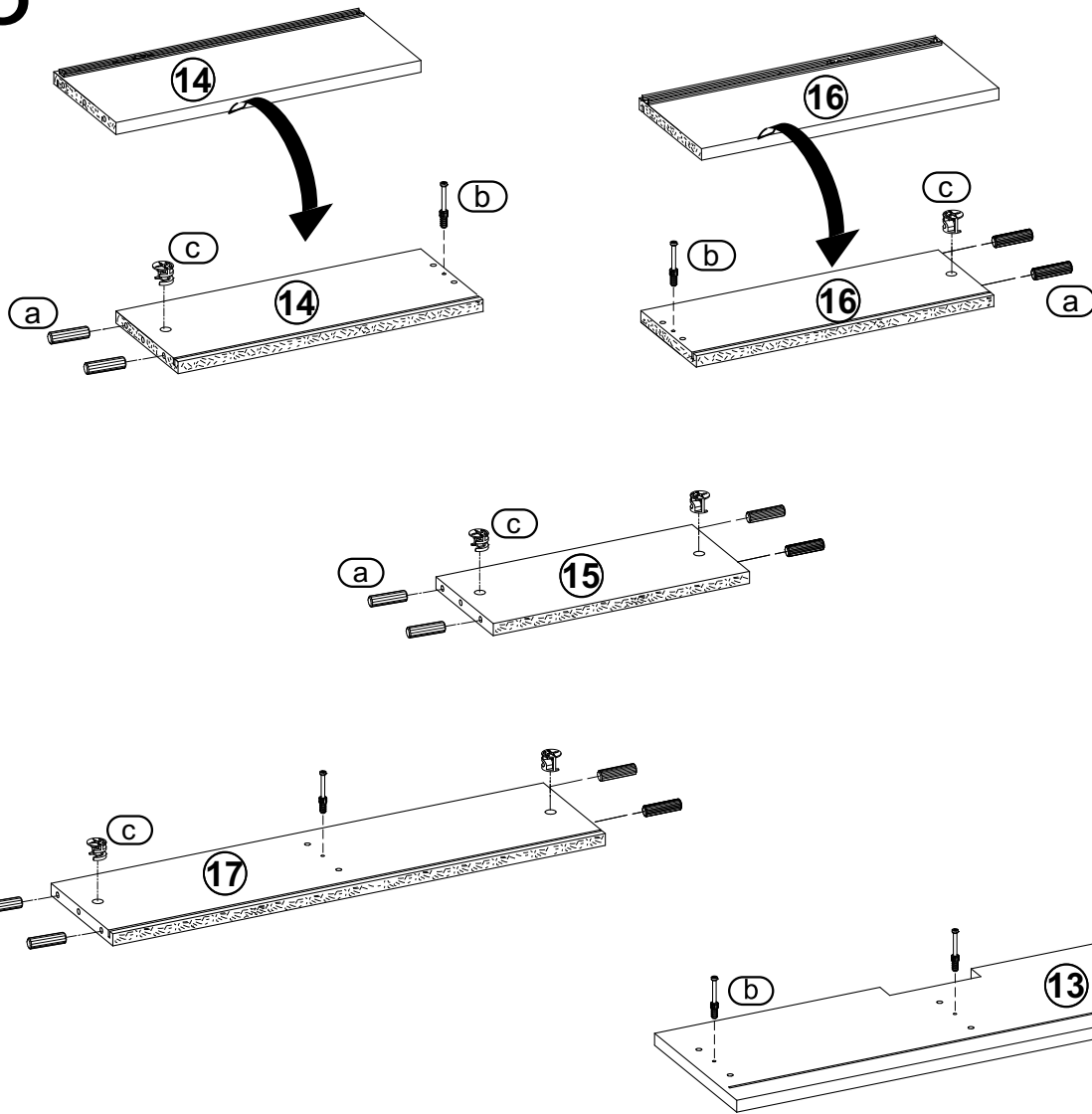

29

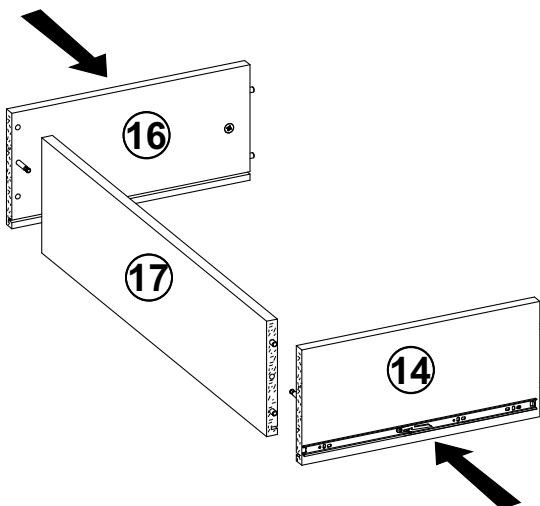
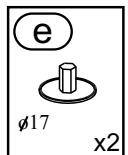
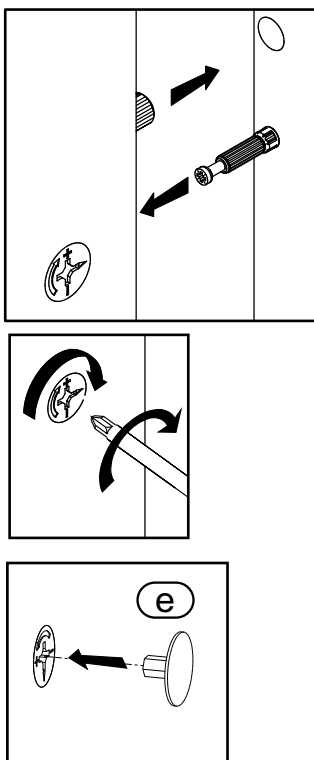

30

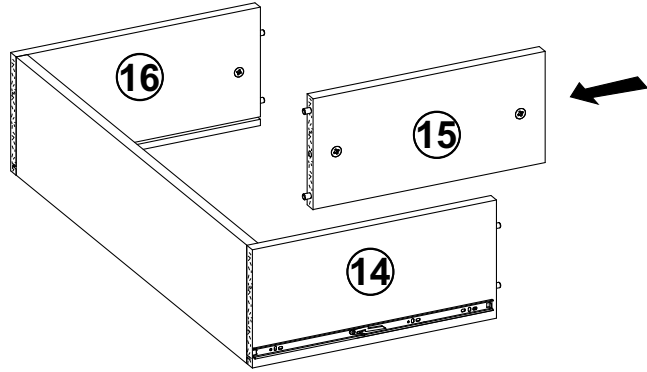
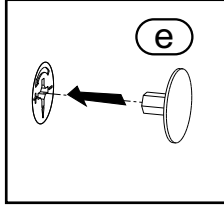
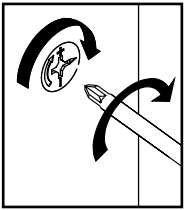
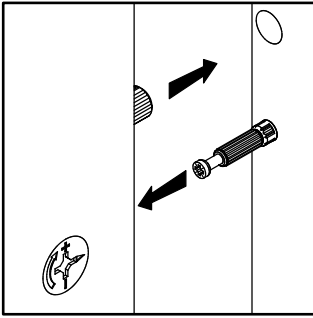
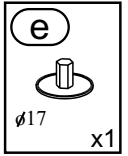

31

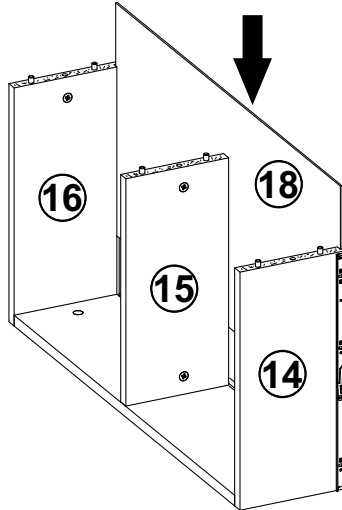

32

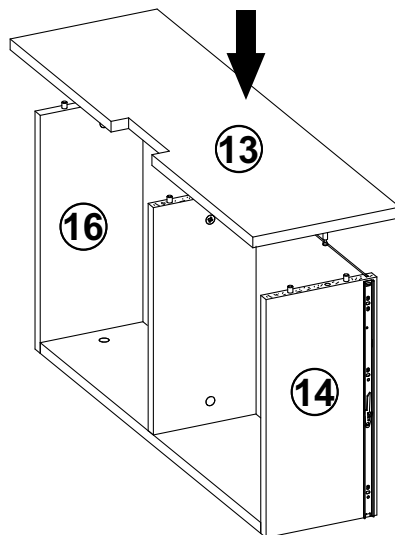
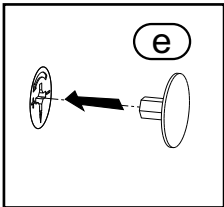
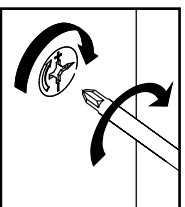
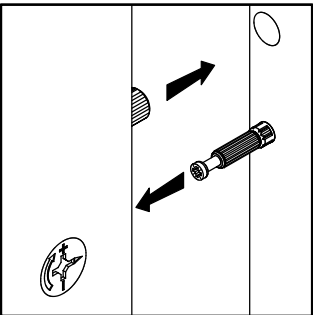
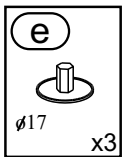

33

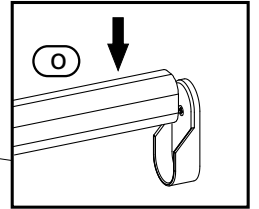
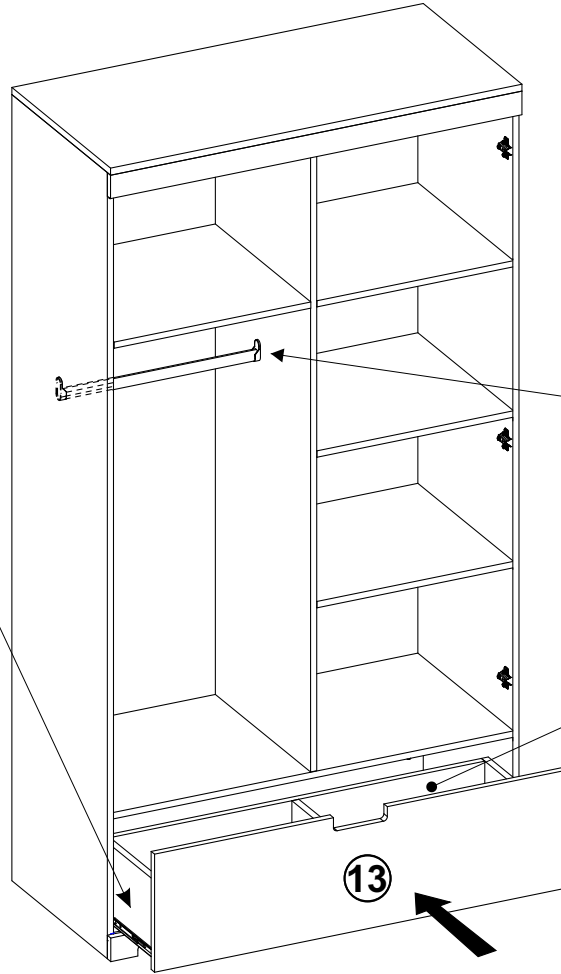
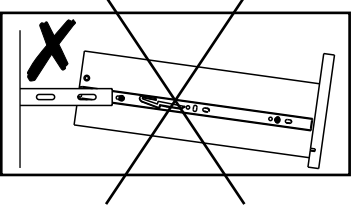
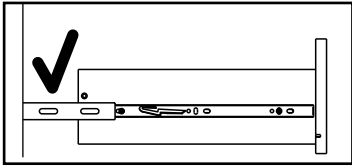
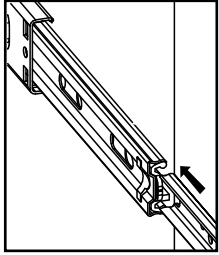
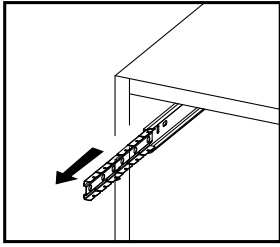
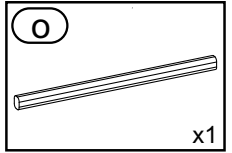

max.
3KG

34

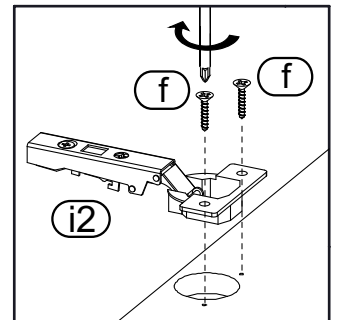
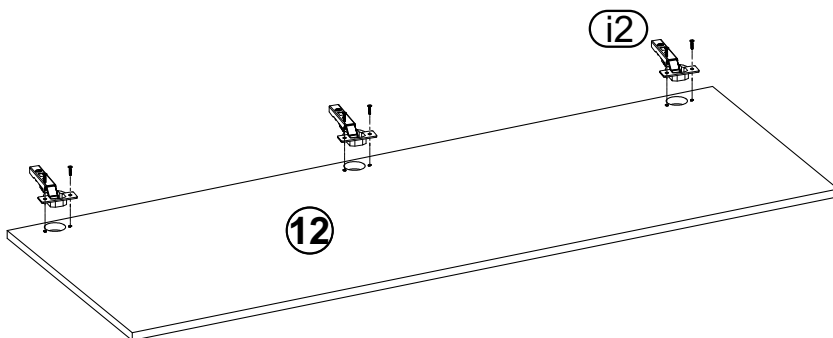
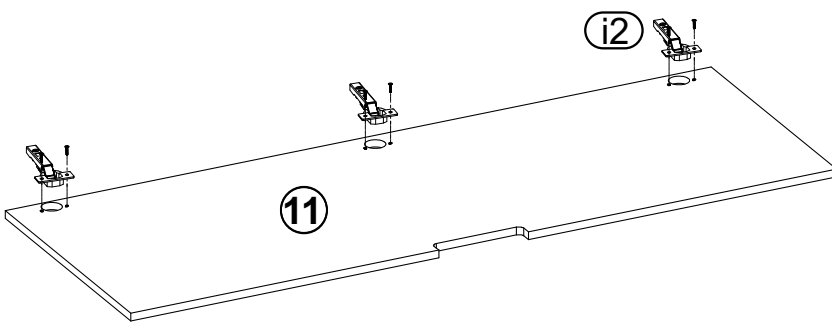
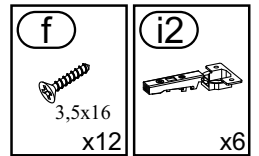

35

(m)
6x60
x2

